

# SupIR 50mm f/1.2, Manual Athermalized 680193

TYPICAL ICD\*

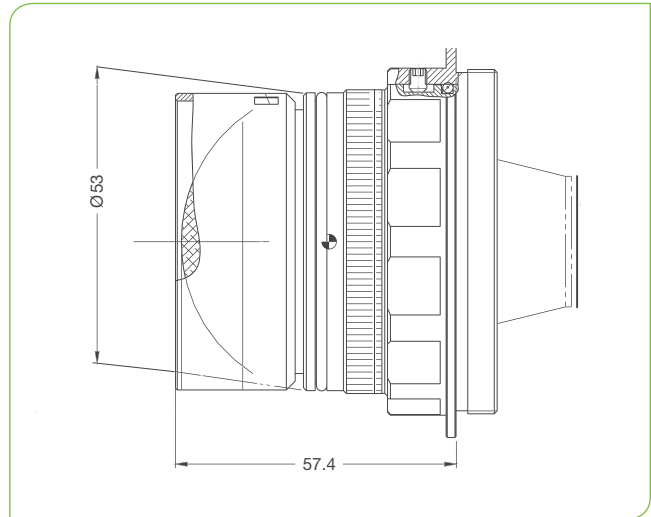

**HD**  
FORMAT



LWIR | 1-FOV

HFOV	320x240	384x288	640x480	1024x768
25μ	9.2°	11.0°	18.3°	
17μ	6.2°	7.48°	12.4°	19.8°
12μ	4.4°	5.3°	8.8°	14.0°

Property	Value				
<b>Optical</b>					
Focal Length	50mm				
F#	1.2				
Average transmission (8-12μm)	85%				
Back Focal Length	29.75mm in air				
<b>Mechanical</b>					
Focus Mechanism	Fixed				
Depth of Field	150m to infinity				
Focus Range	3m to infinity				
Weight	216gr				
Max. Dimensions	Ø53mm x 57.4mm				
<b>Environmental</b>					
Operation Temperature	-40°C to +80°C				
Storage Temperature	-55°C to +85°C				
Sealing	IP 67 front element only				
<b>Configurations</b>	<b>Weight (gr)</b>	<b>Dimensions</b>	<b>BWD**</b>	<b>Thread</b>	<b>Coating</b>
680193-001	216	Ø53mm x 57.4mm	13.65	2 5/16"-36 UNS	HD
680193-002					HC

\* The ICD drawing provided here is primarily a representation and may not accurately reflect the product's actual dimensions and specifications. For precise integration specifications contact your local sales representative.

\*\* The BWD value is calculated for a unique detector setup with varying sealing windows in terms of thickness and material. For more details, contact your local sales representative.